

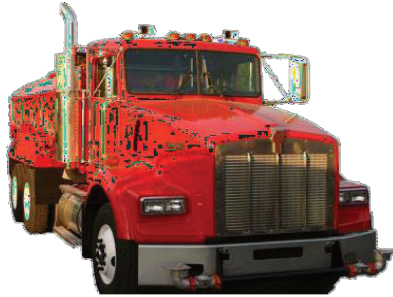





Twyford Business Centre, Bishop's Stortford, CM23 3YT, England

Phone: +44 1279 755590 • Email: [parts@hydexuk.com](mailto:parts@hydexuk.com)





1279 120<sup>th</sup> Ave NE, Bellevue, WA 98005, United States – Phone: +1 800 948-8997





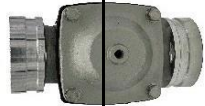

## PREMIUM VALVES











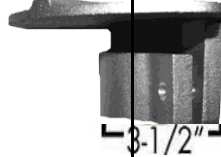

Part#	Dealer Pricing		
<b>101-2-2.5-FPT-3GRV-AL-USA</b> PREMIUM, Aluminum inline diaphragm valve 3" grooved outside and 2 1/2" female NPT on the inside. Air operated, normally open. 7 to 10psi to open, 176 GPM.			
<b>101-2-2-FPT-3GRV-AL-USA</b> PREMIUM, Aluminum inline diaphragm valve 3" grooved outside and 2" female NPT on the inside. Air operated, normally open. 7 to 10psi to open, 176 GPM.			
<b>101-323-GRV-AL-USA</b> PREMIUM, aluminum inline diaphragm valve 3" grooved ends. Air operated, normally open, 7 to 10 psi to open, 176 GPM			
<b>101-323-GRV-AL-PT-USA</b> PREMIUM, aluminum inline diaphragm valve 3" grooved ends. PORTED, Air operated, normally open, 7 to 10 psi to open, 176 GPM			
<b>101-CAP-AL-USA</b> PREMIUM, aluminum replacement cap for the 101-XXX-AL-USA			

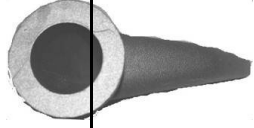
## IMPORT VALVES

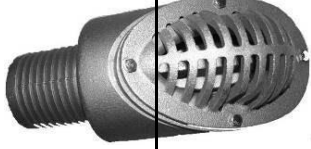
<b>101-323-GRV-AL-Import</b> Inline Diaphragm Valve 3" grooved 2" body aluminum, 176gpm.c, Normally open. 7 to 10psi to open. 176GPM			
<b>101-323-GRV-AL-PT</b> Inline Diaphragm Valve 3" grooved 2" body aluminum ported, 176gpm.c, 3-way solenoid & air operated. Normally open. 7 to 10psi to open. 176GPMc			
<b>101-2"-GRV-AL-PT</b> Inline Diaphragm Valve 2" grooved aluminum ported, 176gpm.c, 3-way solenoid & air operated. Normally open. 7 to 10psi to open. 176GPMc			
<b>101-323"-GRV-ST</b> Inline Diaphragm Valve 3" Vic grooved 2" body Steel, 176gpm.c, Air operated only. Normally Open.			

<p><b>101-323"-GRV-ST-PT</b>          Inline Diaphragm Valve 3" grooved 2" body Steel ported, 176gpm.c, 3-way solenoid &amp; air operated. Normally open. 7 to 10psi to open. 176GPMc</p>			
<p><b>101-2"-GRV-ST-PT</b> Inline Diaphragm Valve 2" grooved Steel ported, 176gpm.c, 3-way solenoid &amp; air operated. Normally Open.</p>			
<p><b>101-2-NPT-AL-PT</b>          Inline Diaphragm Valve 2" FNPT Aluminum ported, 176gpm.c, 3-way solenoid &amp; air operated) Normally open. 7 to 10psi to open. 176GPMc</p>			
<p><b>101-323-NPT-ST</b> Inline Diaphragm Valve 3" FNPT 2" body Steel, 176gpm.c, Air operated) Normally open.</p>			
<p><b>101-323-NPT-ST-PT</b> Inline Diaphragm Valve 3" FNPT Steel ported, 176gpm, 3-way solenoid &amp; air operated. Normally open. 7 to 10psi to open. 176GPMc</p>			
<p><b>101-2-NPT-ST-PT</b> Inline Diaphragm Valve 2" FNPT Steel ported, 176gpm, 3-way solenoid &amp; air operated. Normally open. 7 to 10psi to open. 176GPMc</p>			
<p><b>G101-500BPSI</b>          Rubber Diaphragm gasket for 101 Valve to 233wpsi</p>			
<p><b>101-SPRING AND BUTTON</b>          SPRING AND PLASTIC BUTTON FOR 101 PORTED VALVES</p>			

## Elbows and Spray Heads

<p><b>102</b> Elbow 3" grooved aluminum Note! 102 is a higher flow, longer Elbow than Standard Vic Style, allows for more adjustment with 103 Spray Head</p>			
<p><b>103</b> Adjustable slip-on Deflector Splash Head aluminum.</p>			
<p><b>104</b> Spray Head Straight Outlet Vic Grooved aluminum.</p>			
<p><b>105</b> Foot Valve 3" hose barb aluminum works in shallow streams.</p>			
<p><b>106</b> Spray Head Elbow Outlet 3" aluminum Grooved</p>			
<p><b>110</b> 3" Adjustable Fan spray nozzle, Grooved Aluminum (Adjustable)</p>			
<p><b>111</b> 3" Side spray head 1/4" x 5" Slot, Grooved Aluminum.</p>			
<p><b>112</b> 3" Flusher nozzle 3/32" x 7" Slot, Grooved Aluminum.</p>			
<p><b>Steel Splash Head</b></p>			
<p>SPLASHHEAD-2-MPT</p>			
<p>SPLASHHEAD-2 1/2-MPT</p>			
<p>SPLASHHEAD-3-MPT</p>			
<p>SPLASHHEAD-2-GRV</p>			
<p>SPLASHHEAD-2 1/2-GRV</p>			
<p>SPLASHHEAD-3-GRV</p>			

	Flow (GPM)					
	Model					
Pressure (PSI)	104	106	108	110	111	112
20	260	320	315	420	220	285
30	320	360	360	480	260	345
40	360	405	395	515	300	390
50	415	450	435	560	330	450
60	470	485	455	630	360	500
70	505	505	500	680	400	545
80	525	550	525	750	425	575

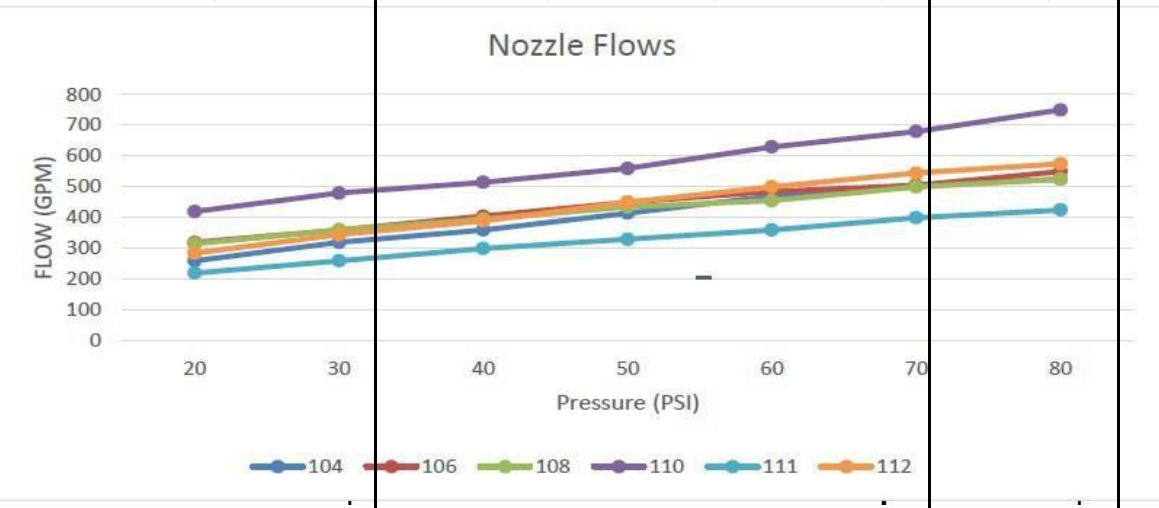

**SPRAY CAP**  
slotted spray head

SPRAYCAP-2

SPRAYCAP-21/2

SPRAYCAP-3

SPRAYCAP-MPT-2x4

Cap w/4"nipple

Not Tightened

SPRAYCAP-MPT-21/2x4

Cap w/4"nipple

Not T

SPRAYCAP-MPT-3x4

Cap w/4"nipple

Not T

SPRAYCAP-GRV-2

Cap w/GV-nipple, Not Tightened





SPRAYCAP-GRV-21/2



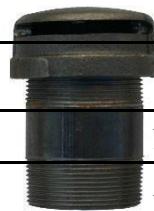

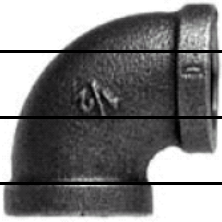
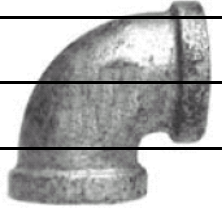



Cap w/GV-nipple, Not Tightened



SPRAYCAP-GRV-3

Cap w/GV-nipple, Not Tightened









<b>ELBOWS</b>				
ELBOW-90-2B (black)				
ELBOW-90-21/2B				
ELBOW-90-3B				
ELBOW-90-2G (galvanized)				
ELBOW-90-21/2G				
ELBOW-90-3G				
<b>107-A</b> 90 Valved, 4" Inlet Grooved x 3" GRV outlet aluminum Normally closed, air to open. <b>Use GV-4-3-RCP-E to attach to 3"</b>				
<b>108-INLINE-VALVE-ATP</b> NORMALLY CLOSED, inline valve, air to open. 3' groove connections.				
<b>108-ASSY</b> Integral Adjustable Spray Head Valve 3" Vic grooved, normally closed, air to open.				
<b>108-ASSY</b> Integral Adjustable Spray Head Valve 3" Vic grooved, normally closed, air to open.				

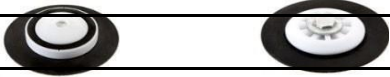





<p><b>108-ASSY</b> Integral Adjustable Spray Head Valve 3" Vic grooved, normally closed, air to open.</p>			
<p><b>108-REPAIR-I.KIT</b> ball, poppet, spring, diaphragm, nuts, and washers</p>			
<p><b>108-POPPET-KIT</b> poppet, spring, ball, nuts, washers, (diaphragm not included)</p>			
<p><b>108-Ball</b></p>			
<p><b>108-Band</b></p>			
<p><b>108-Cap</b></p>			
<p><b>108-Clamp</b></p>			
<p><b>108-Diaphragm</b></p>			
<p><b>108-Poppet</b></p>			
<p><b>108-Spring</b></p>			
<p><b>108-NUT-HEX-SS</b></p>			
<p><b>108-NUT-NYLOCK</b></p>			
<p><b>108-WASHER-SS</b></p>			
<p><b>108-DB-1/4x41/2"</b></p>			
<p><b>108-DB-3/16x61/2"</b></p>			
<p><b>108-DB-5/16x31/2"</b></p>	<p>Side spray attachment for 108</p>		
<p><b>108-4"</b> Integral Adjustable Spray Head Valve 4" Vic grooved Normally closed, air to open. 25% more flow 108</p>			
<p><b>108-4"-Ball</b></p>			
<p><b>108-4"-Poppet</b></p>			
<p><b>108-4"-Spring</b></p>			
<p><b>108-Diaphragm</b></p>			

<p><b>109</b> Air Actuated Air Valve (90) for spray heads) Normally open air to close.</p>			
<p><b>109 Replacement parts</b></p>			
<p><b>109-Diaphragm</b></p>			
<p><b>109-Ball-Half</b></p>			
<p><b>109-Cap</b></p>			
<p><b>109-Locator-Nut</b></p>			
<p><b>109-Repair-Kit</b></p>	<p>Ball-Diaphragm-Spring-Locator</p>		
<p><b>109-Spring</b></p>			
<p><b>113-3</b> MEGA/AGM style spray head, 3", with adjustable spray pattern</p>			
<p><b>113-3-HYD</b> Hydraulic Version of the MEGA/AGM style spray head, 3", with adjustable spray pattern</p>			
<p><b>115-3-GV</b> 3" MINI VERSION OF 113 WITH Grooved inlet port Aluminum</p>			
<p><b>115-3GV-2.5FPT</b> 3" MINI VERSION OF 113 WITH 3" Grooved and 2 1/2" NPT threaded inlet port Aluminum</p>			
<p><b>115-3-DIAPHRAGM</b></p>			
<p><b>115-3-DIAPHRAGM-KIT</b></p>			
<p><b>113-3-AGM-ADAPTER-PLATE</b></p>			
<p><b>113-3-DIAPHRAM</b></p>			
<p><b>113-3-KNOB</b></p>			
<p><b>113-3-MOUNTING PLATE</b></p>			
<p><b>113-3-O-RING</b></p>			
<p><b>113-HYD-CYLINDER</b></p>			
<p><b>113-MOUNTING-BOLT</b></p>			
<p><b>113-MOUNTING-BOLT-WASHER</b></p>			



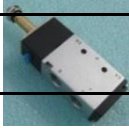





<p><b>CRA-2-Valve-DI</b>      2"</p> <p>inline valve FNPT Full Flow, Heavy Duty 200gpm Ductile Iron Body</p>			
<p><b>CRA-2-Spring</b></p>			
<p><b>CRA-2-Diaphragm-A</b></p>			
<p><b>CRA-2-Diaphragm-Kit</b></p>			
<p><b>CRA-2.5-Diaphragm-A</b></p>			
<p><b>CRA-2.5-Diaphragm-Kit</b></p>			
<p><b>CRA-2.5-Seat</b></p>			
<p><b>CRA-3-Valve-U</b>      3"</p> <p>inline valve, UNPAINTED FNPT Full Flow, Heavy Duty 400gpm Ductile Iron Body.</p>			
<p><b>CRA-3-Valve-P</b>      3"</p> <p>inline valve, PAINTED FNPT Full Flow, Heavy Duty 400gpm Ductile Iron Body</p>			
<p><b>CRA-3-Valve-Z</b></p> <p>3" inline valve, ZINC COATED FNPT Full Flow, Heavy Duty 400gpm Ductile Iron Body</p>			
<p><b>CRA-3-VALVE-HYD-P</b></p> <p>3" inline valve, ZINC COATED FNPT Full Flow, Heavy Duty 400gpm Ductile Iron Body</p>			
<p><b>CRA-3-SPRING</b></p> <p>Replacement spring</p>			
<p><b>CRA-3-SEAT</b></p> <p>Small rubber spring seat</p>			
<p><b>CRA-3-DIAPHRAM</b></p>			
<p><b>CRA-3-Diaphram-Kit</b></p>			

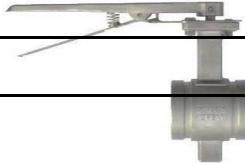

## AGM REPLACEMENT PARTS

<b>AGM-TOGGLE-SWITCH</b> 12/24 Volt Electric Toggle Switch			
<b>AGM-SOLENOID-N/O</b> Electric Solenoid valve-Normally Open			
<b>AGM-SOLENOID-N/C</b> Electric Solenoid valve- Normally Closed			
<b>AGM-SOLENOID-DA</b> Electric Solenoid Valve-Double Action			
<b>AGM-COIL-12V</b>			
<b>AGM-COIL-24V</b>			
<b>AGM-VALVE-REPAIR-KIT</b>			
<b>AGM-VALVE-DIAPHRAM</b>			
<b>AGM-VALVE-RUB-SEAT</b>			
<b>AGM-VALVE-SPRING</b>			





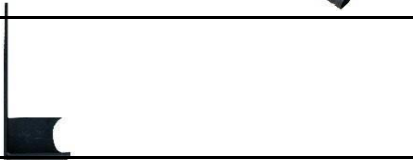

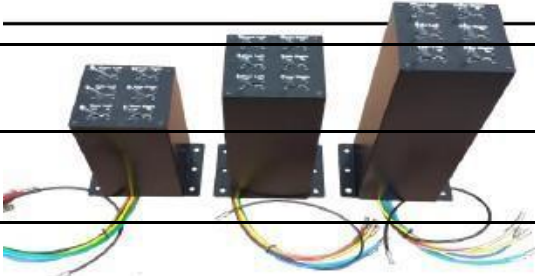

## GROOVED BUTTERFLY VALVES

<b>BFV-B-GVNL-2.5-GY</b>			
<b>BFV-NSF-GVEL-3-BL</b>			
<b>BFV-NSF-GVEL-4-BL</b>			
<b>VALVE KITS</b>			
<b>101-323-AL-103SHEA</b> Splash head Elbow kit: Includes 101-323-GRV-AL, 102, 103, (1)GV-3-CP-R-E			
<b>101-323-ST-103SHEA</b>	Same as above but with Steel valve		
<b>Above valve, parts come separate. If you want them assembled, with push to connect fittings, add -A to part #</b>			
<b>101-323-AL-104SOA</b> Spray outlet assy Includes: 101-323-GRV-AL, 104, (1)GV-3-CP			
<b>101-323-ST-104SOA</b>	Same as above but with Steel valve		
<b>Above valve, parts come separate. If you want them assembled, with push to connect fittings, add -A to part #</b>			

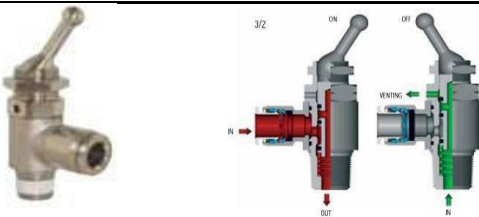
<p><b>101-323-AL-104SOEA</b>          Spray outlet Elbow Assy kit          Includes: 101-323-GRV-AL, 104,          102, (2)GV-3-CP-R</p>			
<p><b>101-323-ST-104SOEA</b></p>	<p>Same as above but with Steel valve</p>		
<p><b>Above valve, parts come separate. If you want them assembled, with push to connect fittings, add -A to part #</b></p>			
<p><b>101-323-AL-106SEA</b>          Spray Elbow Assy Includes: 101-323-GRV, 102, 106, (2) GV-3-CP-R-E</p>			
<p><b>101-323-ST-106SEA</b></p>	<p>Same as above but with Steel valve</p>		
<p><b>Above valve, parts come separate. If you want them assembled, with push to connect fittings, add -A to part #</b></p>			
<p><b>108-Elbow Assy</b> Integral          Spray Head valve 3" Vic grooved          Includes:108, GV-90-3, GV-3-CP, QEV-set</p>			
<p><b>Above valve, parts come separate. If you want them assembled, with push to connect fittings, add -A to part #</b></p>			
<p><b>108-DBSOEA</b>          Duckbill side spray assy.          Includes: 108, 108-DB-1/4x4.5, GV-3-CP-R,QEV+</p>			
<p><b>Above valves assembled with push to connect fitting add -A to part# &amp;</b></p>			
<p><b>109-110ASHA</b>          Adjustable spray head assy includes          109, 110, 1-GV-3-CP-R, QEV+</p>			
<p><b>Above valve, parts come separate. If you want them assembled, with push to connect fittings, add -A to part #</b></p>			
<p><b>109-111SOEA</b>          109 side spray assy. Includes 109, 111, 1-GV-3-CP-R, QEV+</p>			
<p><b>CRA-3-104SOEA</b></p>			
<p><b>Above valve, parts come separate. If you want them assembled, with push to connect fittings, add -A to part #</b></p>			

<b>Plumbing-FSB-3"X40"-Sch40BIP</b> Front Spray Bar, 3", groove x groove, (brackets not included)			
<b>Plumbing-RSB-3"X48"Sch40Bip</b> Rear Spray Bar, 3", groove x groove, (brackets not included)			
<b>PLUMBING-FSB-BRACKET</b> Front spray bar bracket, for 3" pipe, (need 2 to mount spray bar)			
<b>PLUMBING-RSB-BRACKET</b> Rear Spray Bar bracket, for 3" pipe, (need 2 to mount spray bar)			
<b>CONTROL TOWERS-IN CAB</b> These towers come in 3 heights, 12", 16", 20". They are 7" x 7" square. They are fully plumbed with switches installed and airline 18" out			
<b>MAKE SURE AND SPECIFY IF THE VALVES TO BE OPERATED ARE NORMALLY OPEN OR CLOSED WITH "NO" OR "NC" IN THE PART #</b>			
<b>KWIK-E-TOWER-5-12T-NO</b>			
<b>KWIK-E-TOWER-5-12T-NO-DOT</b>			
<b>KWIK-E-TOWER-5-16T-NO</b>			
<b>KWIK-E-TOWER-5-16T-NO-DOT</b>			
<b>KWIK-E-TOWER-5-20T-NO</b>	<ul style="list-style-type: none"> <li>• <b>Tower Dimensions</b></li> <li>• 12", 16" and 20" Tall</li> <li>• 7" x 7" Square</li> </ul>		
<b>KWIK-E-TOWER-5-20T-NO-DOT</b>	<ul style="list-style-type: none"> <li>• 2 Mounting Legs 1 1/2" x 7"</li> <li>• 6 Mounting Holes, 1/2"</li> <li>• <b>Features</b></li> </ul>		
<b>KWIK-E-TOWER-6-12T-NO</b>	<ul style="list-style-type: none"> <li>• Powder Coated Exterior</li> <li>• Silk Screen Labels</li> <li>• Removable Top Plate</li> </ul>		
<b>KWIK-E-TOWER-6-12T-NO-DOT</b>	<ul style="list-style-type: none"> <li>• Reversible Switch Mounting</li> </ul>		
<b>KWIK-E-TOWER-6-16T-NO</b>	<ul style="list-style-type: none"> <li>• These towers will have air lines (pigtailed) installed.</li> <li>• Each pigtail will have 18" of length out the bottom of the tower, and have a union coupler on it for easy installation. This will also give you a great break point to replace any air lines that get damaged in the future.</li> </ul>		
<b>KWIK-E-TOWER-6-16T-NO-DOT</b>			
<b>KWIK-E-TOWER-6-20T-NO</b>	<ul style="list-style-type: none"> <li>• The pigtailed are color coded to their switch for quick identification.</li> <li>• You will have the option of having your Logo screen printed on the top plate, with volume orders.</li> </ul>		
<b>KWIK-E-TOWER-6-20T-NO-DOT</b>			

<p><b>SPRING-MOUNTS</b> TIE DOWN SPRINGS FOR TRUCK BODIES.</p>		
<p><b>TANK-SOUNDSTRIPS-21/2X48</b> Rubber pads, with steel backing, for cushion between the tank and the truck frame. Can be welded directly to tank sub-frame.</p>		
<p><b>WLA300-A12</b> TANK VISION GAUGE, PRIMARY KIT WITH GREEN FULL INDICATOR. COMES WITH SENSOR AND CABLES</p>		<p>SEE MONITOR CATALOG</p>
<p><b>WLA300-A03-S30</b> KIT WATER DISP TANKVISION WLA300-A12 WITH A 30' HARNESS</p>		<p>SEE MONITOR CATALOG</p>
<p><b>WLA205-A00</b> Water display, Tank Vision, Cab Mini</p>		<p>SEE MONITOR CATALOG</p>
<p><b>WLA280-A00</b> MAXVISION LED DISPLAY, COMES WITH 1) XE-WL280-D0A DISPLAY, 1) XE-WLA2PM-R0A REF PROD MANUAL TANK VISION, AND 1) XE-XXDLTERMW-A0A ACCY DATA-LINK TERM RES W/WIRES</p>		<p>SEE MONITOR CATALOG</p>
<p><b>XE-WLPT-S0A</b> TANK VISION SENDING UNIT</p>		<p>SEE MONITOR CATALOG</p>
<p><b>XE-WLS200S-C30A</b> CABLE TANK VISION SENSOR 30FT</p>		<p>SEE MONITOR CATALOG</p>
<p><b>RVS-CAMERA-SYSTEM-1C</b> WIRELESS BACKUP CAMERA SYSTEM, COMES WITH ONE CAMERA</p>		<p>SEE MONITOR CATALOG</p>
<p><b>RVS-CAMERA-ONLY</b> WIRELESS BACKUP ADD ON CAMERA. THIS IS A CAMERA ONLY TO ADD TO THE ABOVE KIT FOR DUAL DISPLAY</p>		<p>SEE MONITOR CATALOG</p>
<p><b>RVS-082507</b> RVS REAR CAMERA SYSTEM, WIRED</p>		<p>SEE MONITOR CATALOG</p>
<p><b>MANSAVER-BARS</b> MANSAVER BARS, 14" through 36". must specify length when ordering. cost is the same for all lengths. price per one bar</p>		<p>SEE MONITOR CATALOG</p>

<p><b>QEV-90-1/8-FPT</b> Quick exhaust valve for air exhaust, on 108/109 for better performance.</p>			
<p><b>QEV-90-1/8-FPT-SET</b> Quick exhaust valve for air exhaust on 108/109 for better performance. Ready to install.</p>			
<p><b>PT-1/8</b> Air Control Flipper Valve On-Off Two position chrome plated steel handle.</p>			
<p><b>Toggle-Air-Switch-3/2-1/8</b> Compact Air Toggle Switch. 3/2 Cuts off the flow and vents to the Atmosphere. 1/8 mpt x 1/4 tube fitting.</p>			
<p><b>Toggle-3way-Switch-1/8</b></p>			
<p><b>Toggle-4way-Switch-1/8</b></p>			
<p><b>CYL-Air-2x6"-Side-Spray</b> Double acting 2" cyl, 6" stroke, 145psi, NBR</p>			
<p><b>CYL-ROD-EYE</b></p>			
<p><b>CYL-ROD-FORK</b></p>			



**GROOVE PLUMBING KITS- NO WELDING NEEDED**

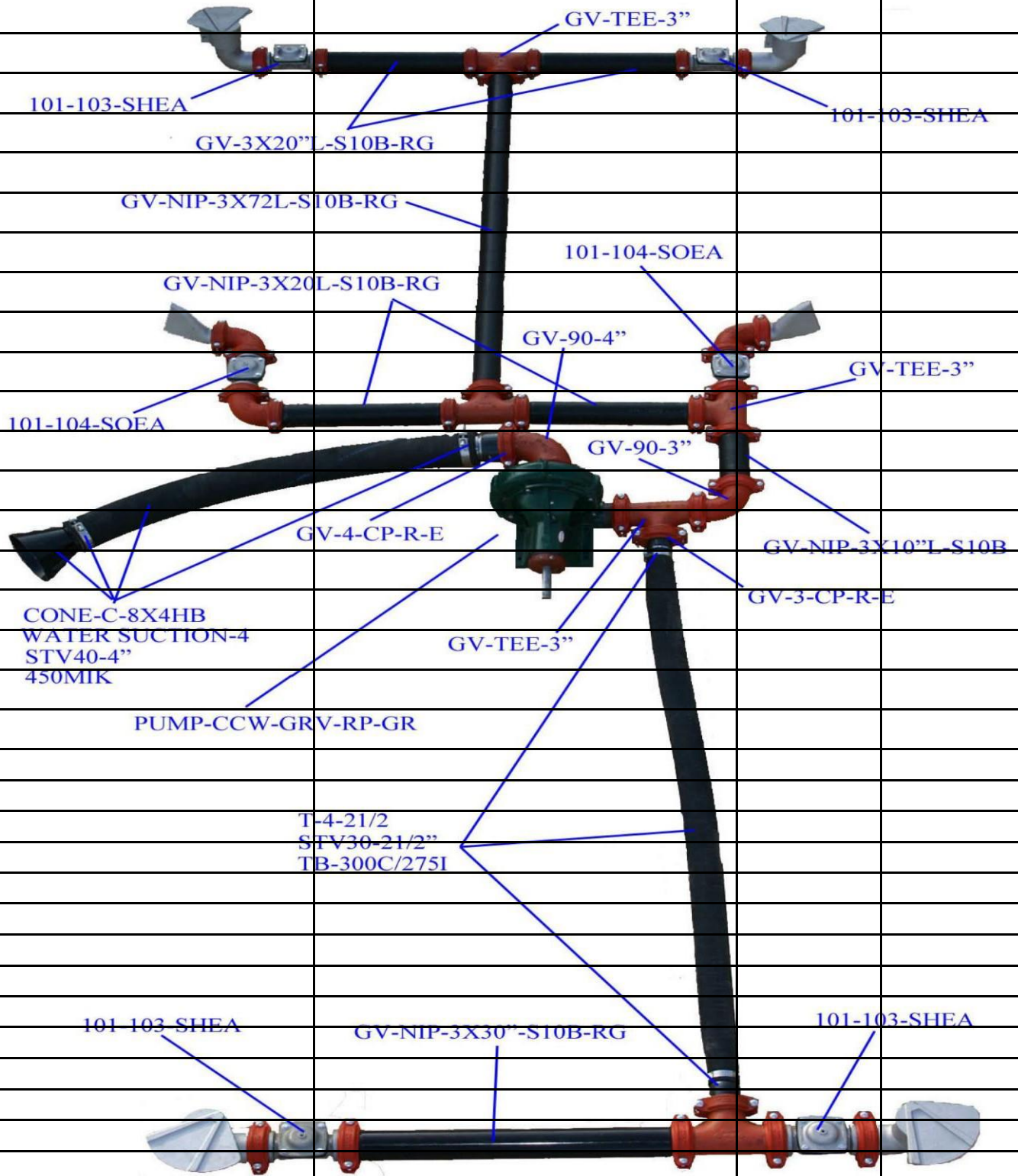

**GRV-6 SPRAY-KIT-101** Plumbing kit with all groove connection, includes ALL pipe, pump, clamps, valves, hose, KWIK-E-TOWER, ect. Needed to install a 6 spray system on a water truck with 101 groove inline valves.

**SEE PICTURE ABOVE**  
(SOME ADJUSTMENTS MAY HAVE TO BE MADE TO FIT YOUR TURCK)



**PLUMBING KITS- WELDING REQUIRED**

**PLUMBING-ID-KIT-3"** Inlet-Discharge Kit-includes pump bracket, weld fittings, hose, fittings and clamps needed to plumb from tank to pump and out to pressure manifold. **For list of parts, request Quote #8389**



**PLUMBING-FSB-KIT-3"** Front Spray Bar Kit-includes Pipe, hose, clamps, valves, spray heads and air controls to plumb a spray bar from the pump manifold. **For list of parts, request quote #8384**



**PLUMBING-RSB-KIT-3"** Rear Spray Bar Kit-includes Pipe, clamps, valves, spray heads and air controls to plumb a spray bar from the pump manifold. **For list of parts, request quote #8385**



**PLUMBING-DSS-KIT-3"** Side Spray Kit (Drivers side) includes: weld fittings, valves, spray heads and air controls to plumb a side spray off the pump manifold. **For list of parts, request quote #8386**



**PLUMBING-PSS-KIT-3"** Additional Side Spray Kit (Passenger side)-includes: pipe, weld fittings, valves, spray heads and air controls to plumb a side spray off the pump manifold. **For list of parts, request quote #8388**



**Easily add the ability to Draft to your water truck from a pond, river, pool etc.**

**Draft-Kit-4x3-GV-Complete**  
Fits onto your pump's inlet, everything needed to draft from rivers, creeks, ponds etc. and fill your tank. Manually operated.













**Draft-Kit-4x3-GV** Fits onto your pump's inlet, Allows you to draft Manually operated.









**Draft-kit-4X3GV-W/pump**  
**Draft kit, with PRIMER PUMP KIT.**  
Everything you need on the suction side of the pump to complete a self loading system





<p><b>Draft-Kit-4x3-GV-Air-Complete</b> Fits onto your pump's inlet, everything needed to draft from rivers, creeks, ponds etc. and fill your tank. Air operated just flip a switch from your cab, minimal thought needed to operate.</p>			
<p><b>Draft-Kit-4x3-GV-Air</b> Fits onto your pump's inlet, Air operated just flip a switch from your cab, minimal thought needed.to operate.</p>			
<p><b>Draft-Tee-4-for Air</b> Tee for above Air actuated draft kit.</p>			
<p><b>Draft-Kit-3-GV-Air-Complete</b> Fits onto your pump's inlet, everything needed to draft from rivers, creeks, ponds etc. and fill your tank. Air operated just flip a switch from your cab, minimal thought needed.</p>			
<p><b>Draft-Kit-3-GV-Air</b> Fits onto your pump's inlet, Air operated just flip a switch from your cab, minimal thought needed.</p>			
<p><b>Draft-Tee-3-for Air</b> Tee for above Air actuated draft kit.</p>			
<p><b>Draft-Tank-to-Pump-hose 4"</b> hose for making flexible connect between the Tank &amp; the Pump (Grooved end for pump connection.)</p>			
<p><b>DRAFT-Suc-Hose-#1M-3"x10'</b> 3" Suction Hose (S115-3) W/Horizontal Foot Valve (105) &amp; M Cam10' OVL</p>			
<p><b>DRAFT-Suc-Hose-#1F-3"x10'</b> 3" Suction Hose (S115-3) W/Horizontal Foot Valve (105) &amp; F Cam10' OVL</p>			

<p><b>DRAFT-Suc-Hose-#2-3"x10'</b>  3" Suction Hose (S115-3)  W/Horizontal Foot Valve (105) &amp; F  Cam10' OVL</p>			
<p><b>DRAFT Tank-Fill-Hose</b> Use to  <b>fill Tank when Drafting</b> Attach to  side spray valve or any spray  valve/elbow that is grooved/Vic!  Throw other end into the tank and fill  your tank. 20'Ovl</p>			
<p><b>Draft Primer Pumps</b></p>			
<p><b>#DPPH-5G</b> Pump  designed for 2", 3" and 4" pipe or  hose size. Will fill a 4" x 25' long  suction hose with 10 strokes.</p>			
<p><b>#DPPH-7G</b> Pump  designed for 4", 5" and 6" pipe or  hose size. Will fill a 4" x 25' long  suction hose with 6 strokes.</p>			
<p><b>#Draft-Primer-Dp9</b>  Pump designed for 6", 8" or larger  pipe or hose size. Will fill a 6" x  25' long suction hose with 10  strokes.</p>			
<p><b>Draft-Primer-DP5-Kit-tee</b>  pump kit includes pump,  bracket, groove tee with hose  barb, hose and grv. Clamp</p>			
<p><b>Draft-Primer-DP5-Kit-nip</b>  pump kit includes pump,  bracket, groove tee with hose  barb, hose and grv. Clamp</p>			
<p><b>Draft-Primer-DP7-Kit-NIP</b></p>	<p>SAME KIT AS ABOVE WITH DP7 PUMP</p>		
<p><b>Draft-Primer-DP9-Kit-NIP</b></p>	<p>SAME KIT AS ABOVE WITH DP9 PUMP</p>		
<p><b>DRAFT-PUMP-ADT-TEE</b></p>			
<p><b>DRAFT-PUMP-ADT-NIP</b></p>			



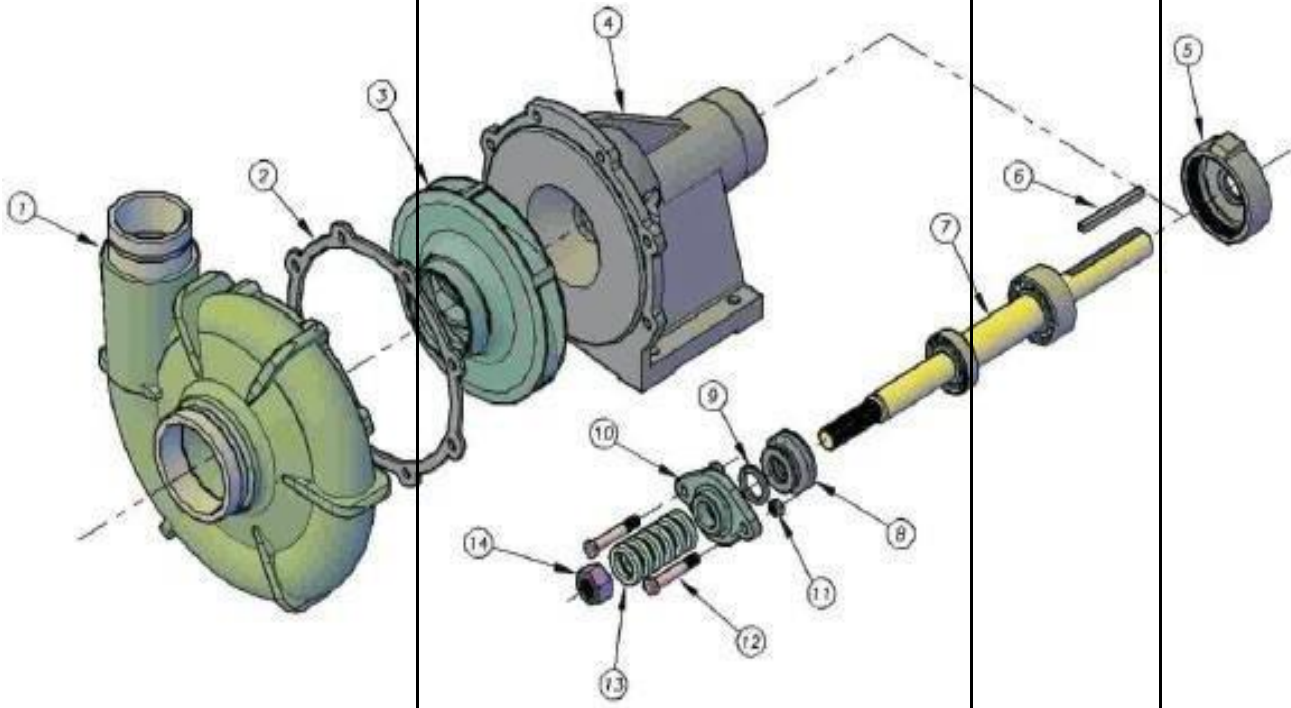







<p><b>HR-HDCR-11/2x50-ST</b>  Hose Reel hand crank handles 50' of 1 1/2 hose. Heavy duty steel frame.  <u>Beveled gear for ease of Cranking!</u>  <b>Greased bearings!</b></p>			
<p><b>HR-HDCR-W/11/2X50'-BK</b>  Above reel with 50' of 1 1/2" 250wpsi black water/air hose cpld Mpt x Mpt and installed on reel.</p>			
<p><b>HR-HDCR-W/1X100'-BK</b>  Above reel with 100' of 1" 300wpsi black water/air hose cpld Mpt x Mpt &amp; installed on reel.</p>			
<p><b>HR-HDCR-Kit-11/2x50-BK.</b>  Ready to install reel kit w/50' of 1 1/2" hose (installed on reel), Nozzle, 5' of feed hose, 2-mpt hose barbs &amp; clamps, tank nipple, Ball Valve &amp; St Elbow.</p>			
<p><b>HR1-15-1185-CRANK</b>  HAND CRANK, medium duty, Holds 50' of 1.5" hose</p>			
<p><b>SD14050 OLP</b>  SPRING REWIND, 1" X 50' REEL ONLY, HOSE SOLD SEPARATE</p>			
<p><b>FF9600 OLPBW</b>  SPRING REWIND CAN HOLD 50' OF 1 1/2", REEL ONLY, HOSE SOLD SEPARATE</p>			
<p><b>HR-EP7528-19-21-RT</b>  HANNAY ELECTRIC HOSE REEL, 1 1/2" X 50, HEAVY FRAME REEL. REEL ONLY, HOSE SOLD SEPARATE</p>			
<p><b>HR HOSE KITS</b></p>	<p>INCLUDES HOSE WITH MNPT ENDS, NOZZLE, 5' OF FEED HOSE WITH MNPT ENDS, NIPPLE, BALL VALVE AND NOZZLE</p>		
<p><b>HR-HOSE-KIT-1"X50'-BK</b></p>			
<p><b>HR-HOSE-KIT-1"X100'-BK</b></p>			
<p><b>HR-HOSE-KIT-1 1/2"X50'-BK</b></p>			
<p><b>HR HOSE ASSEMBLIES</b></p>	<p>HOSE REEL HOSE ASSEMBLIES, MNPT ENDS</p>		
<p><b>1-200ER-BK-MP<sub>x</sub>MPX-50'</b></p>	<p>1" x 50'</p>		
<p><b>1-200ER-BK-MP<sub>x</sub>MPX 100'</b></p>	<p>1" x 100'</p>		
<p><b>ER1.5-200BK-MPXMP-CRS-50</b></p>	<p>1 1/2 x 50'</p>		

## Pump Parts













<b>PUMP-VALUTE-CCW-GRV</b>	#1	SEE PUMP CATALOG
<b>PUMP-GASKET</b>	#2	SEE PUMP CATALOG
<b>PUMP-CCW-IMPELLER</b>	#3	SEE PUMP CATALOG
<b>PUMP-3-BASE-#4</b>	#4	SEE PUMP CATALOG
<b>PUMP-OUTER-BEARING-</b>	#5	SEE PUMP CATALOG
<b>Pump-CCW-SHAFT-KIT</b>	Includes # 6,7 and 14	SEE PUMP CATALOG
<b>PUMP-INNER-BEARING-CAP</b>	#8	SEE PUMP CATALOG
<b>PUMP-SLINGER</b>	#9	SEE PUMP CATALOG
<b>PUMP-PACKING-GLAND</b>	#10	SEE PUMP CATALOG
<b>PUMP-PACKING-GLAND-</b>	#11	SEE PUMP CATALOG
<b>PUMP-PACKING-GLAN-</b>	#12	SEE PUMP CATALOG
<b>PUMP-PACKING-ROPE-KIT-B</b>	#13	SEE PUMP CATALOG
<b>PUMP-PACKING-ROPE-KIT-M</b>	Rope Packing for Monach NT3M9S	SEE PUMP CATALOG
<b>PUMP-SHAFT-NUT</b>	#14	SEE PUMP CATALOG
<b>PUMP-MECH-SEAL-B</b>	Mechanical Seal for Berkeley B3ZRM	SEE PUMP CATALOG
<b>PUMP-MECH-SEAL-M</b>	Mechanical Seal for Monarch NT3M9S	SEE PUMP CATALOG
<b>PUMP-TO-HYD-ADT</b> Hydraulic Adapter for the Berkeley Pump		SEE PUMP CATALOG

## TRANSPORTERS CHOICE PUMPS

<p><b>PUMP-CCW-GRV-RP-BK</b>  <b>B66895</b>, counterclockwise, 4" x 3" grooved with SS shaft, <b>rope packing</b>, 112 lbs., 750GPM@2500GPM/60PSI</p>		<p>SEE PUMP CATALOG</p>
<p><b>PUMP-CCW-GRV-MS-BK</b>  <b>B68416</b>, counterclockwise, 4" x 3" grooved with SS shaft, <b>mechanical seal</b>, 112 lbs., 750GPM@2500GPM/60PSI</p>		<p>SEE PUMP CATALOG</p>
<p><b>PUMP-CCW-NPT-RP-BK</b>          Berkely style pump, counterclockwise <b>B66168</b> with <b>rope packing</b>, 4" x 3" NPT, with SS shaft, 112 lbs. 750GPM@2500GPM/60PSI</p>		<p>SEE PUMP CATALOG</p>
<p><b>PUMP-CCW-NPT-MS-BK</b>  <b>B68415</b>, counterclockwise 4" X 3" NPT connection, with <b>mechanical seal</b>, with SS shaft, 112lbs 750GPM@2500GPM/60PSI</p>		<p>SEE PUMP CATALOG</p>
<p><b>PUMP-CW-GRV-RP-BK</b>  <b>B66899</b>, clockwise, 4" x 3" grooved with SS shaft, <b>rope packing</b>, 112 lbs., 750GPM@2500GPM/60PSI</p>		<p>SEE PUMP CATALOG</p>
<p><b>PUMP-CW-GRV-MS-BK</b>  <b>B68417</b>, clockwise 4" x 3" grooved with SS shaft, <b>mechanical seal</b>, 112 lbs., 750GPM@2500GPM/60PSI</p>		<p>SEE PUMP CATALOG</p>
<p><b>PUMP-CW-NPT-RP-BK</b>  <b>B66161</b>, clockwise with <b>rope packing</b>, 4" x 3" NPT, with SS shaft, 112 lbs. 750GPM@2500GPM/60PSI</p>		<p>SEE PUMP CATALOG</p>
<p><b>PUMP-CW-NPT-MS-BK, B68414</b>          clockwise, 4" X 3" NPT connection, with <b>mechanical seal</b>, with SS shaft, 112lbs 750GPM@2500GPM/60PSI</p>		<p>SEE PUMP CATALOG</p>
<p><b>PUMP-CCW-NPT-4X4-SP</b>          B69876 Berkeley style pump, 4x4 FNPT self-priming pump, hydraulic drive, 13 ft head, 9" impeller, clockwise rotation, B-mount included, mechanical seal</p>		<p>SEE PUMP CATALOG</p>
<p><b>PUMP-BRACKET-CCW-3/8T-10W</b>          Pump bracket for mounting pump to truck frame</p>		<p>SEE PUMP CATALOG</p>

## BERKELEY PUMPS

<p><b>PUMP-CCW-GRV-RP-OR</b>  <b>B66895, counterclockwise, 4" x 3"</b>          grooved with SS shaft, <b>rope packing</b>, 112 lbs.,          750GPM@2500GPM/60PSI</p>		<p style="text-align: center;">SEE PUMP CATALOG</p>
<p><b>PUMP-CCW-GRV-MS-OR</b>  <b>B68416, counterclockwise, 4" x 3"</b>          grooved with SS shaft, <b>mechanical seal</b>, 112 lbs., 750GPM@2500GPM/60PSI</p>		<p style="text-align: center;">SEE PUMP CATALOG</p>
<p><b>PUMP-CCW-NPT-RP-OR</b>          Berkely style pump, counterclockwise  <b>B66168 with rope packing, 4" x 3"</b>          NPT, with SS shaft, 112 lbs.          750GPM@2500GPM/60PSI</p>		<p style="text-align: center;">SEE PUMP CATALOG</p>
<p><b>PUMP-CCW-NPT-MS-OR</b>  <b>B68415, counterclockwise 4" X 3"</b>          NPT connection, with <b>mechanical seal</b>, with SS shaft, 112lbs          750GPM@2500GPM/60PSI</p>		<p style="text-align: center;">SEE PUMP CATALOG</p>
<p><b>PUMP-CW-GRV-RP-OR</b>  <b>B66899, clockwise, 4" x 3"</b> grooved          with SS shaft, <b>rope packing</b>, 112 lbs.,          750GPM@2500GPM/60PSI</p>		<p style="text-align: center;">SEE PUMP CATALOG</p>
<p><b>PUMP-CW-GRV-MS-OR</b>  <b>B68417, clockwise 4" x 3"</b> grooved          with SS shaft, <b>mechanical seal</b>, 112          lbs., 750GPM@2500GPM/60PSI</p>		<p style="text-align: center;">SEE PUMP CATALOG</p>
<p><b>PUMP-CW-NPT-RP-OR</b>  <b>B66161, clockwise with rope</b>  <b>packing, 4" x 3" NPT</b>, with SS shaft,          112 lbs. 750GPM@2500GPM/60PSI</p>		<p style="text-align: center;">SEE PUMP CATALOG</p>
<p><b>PUMP-CW-NPT-MS-OR B68414</b>          clockwise, 4" X 3" NPT connection,          with <b>mechanical seal</b>, with SS shaft,          112lbs 750GPM@2500GPM/60PSI</p>		<p style="text-align: center;">SEE PUMP CATALOG</p>
<p><b>PUMP-CCW-NPT-4X4-SP-OR</b>          B69876 Berkeley style pump, 4x4 FNPT          self-priming pump, hydraulic drive, 13 ft          head, 9" impeller, clockwise rotation, B-          mount included, mechanical seal</p>		<p style="text-align: center;">SEE PUMP CATALOG</p>
<p>BERKLEY PUMP, B4JRGBHS,          B69743, CW, HYDRAULIC DRIVE,          5" X 4" FLANGE, 13 1/2" IMPELLOR</p>		<p style="text-align: center;">SEE PUMP CATALOG</p>

**WE STOCK MANY OTHER BERKELEY PUMPS AS WELL SO PLEASE CALL FOR PRICING**





<b>PTO'S</b>			
<b>PTO'S FOR WITH ROUND SHAFT AND 1/4 KEY FOR DRIVELINE</b>			
<b>PTO'S FOR WITH B-MOUNT FOR HYDRAULIC PUMPS</b>			
<b>HYDRAULICS: Motors, Pumps, Valves, Hoses, Kits &amp; Accessories.</b>			
<b>Hydraulic Motors.</b>			
			
<b>Hydraulic Pumps</b>			
			
<b>Hydraulic Valves</b>			
			
<b>Hydraulic Filters</b>			
			
<b>Tank Filler/Filter Caps</b>			
<b>Cap-Fil-3B-40mesh</b>		Tank filler/filter Cap w/3"L 40mesh screen	
<b>Tank Kits</b>			
<b>HYD-TANK-25</b> tank only, filter and valve not included.			
<b>Complete Wet Kits: Call for quotes!</b>			





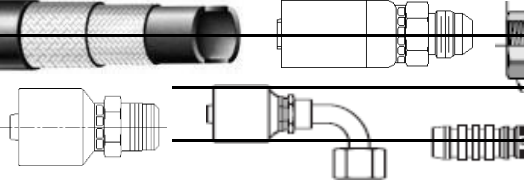
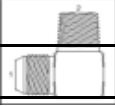

**We have a complete and very Competitive Hydraulic hose & Fitting Program!**

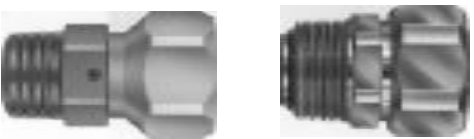

**Gates Fittings & Hose, USA Made Parker, Dayco, Weather head Copy fittings**

**Semperit Hose. Brennan Hyd. Adapters, Flanges & Swivels. Used Crimpers Etc.**

			
<p><b>Swivel-Straight</b> (pipe thread) Anodized Alum/SS 150WPSI Handles water/fuels etc.</p>			
<p>FOA125MF</p>	<p>male pipe x female pipe 1 1/4"</p>		
<p>FOA150MF</p>	<p>male pipe x female pipe 1 1/2"</p>		
<p>FOA200MF</p>	<p>male pipe x female pipe 2"</p>		
<p>FOA250MF</p>	<p>male pipe x female pipe 2 1/2"</p>		
<p>30MF-SV-AL</p>	<p>male pipe x female pipe 3"</p>		
<p>FOA125FF</p>	<p>female pipe x female pipe 1 1/4"</p>		
<p>FOA150FF</p>	<p>female pipe x female pipe 1 1/2"</p>		
<p>FOA200FF</p>	<p>female pipe x female pipe 2"</p>		
<p>FOA250FF</p>	<p>female pipe x female pipe 2 1/2"</p>		
<p>FOA300FF</p>	<p>female pipe x female pipe 3"</p>		
<p><b>Swivel 90-degree elbow</b> (pipe thread) Anodized Alum/SS 150WPSI Handles</p>			
<p>FOA125FF-EL-90-A</p>	<p>female pipe x female pipe</p>		
<p>FOA150FF-EL-90-A</p>	<p>female pipe x female pipe</p>		
<p>FOA200FF-EL-90-A</p>	<p>female pipe x female pipe</p>		
<p>FOA250FF-EL-90-A</p>	<p>female pipe x female pipe</p>		
<p>FOA300FF-EL-90-A</p>	<p>female pipe x female pipe</p>		
<p><b>Swivel 90-degree elbow</b> (pipe thread) Anodized Alum/SS 150WPSI Handles</p>			
<p>FOA125MF-EL-90-A</p>	<p>male pipe x female pipe</p>		
<p>FOA150MF-EL-90-A</p>	<p>male pipe x female pipe</p>		
<p>FOA200MF-EL-90-A</p>	<p>male pipe x female pipe</p>		
<p>FOA250MF-EL-90-A</p>	<p>male pipe x female pipe</p>		
<p>FOA300MF-EL-90-A</p>	<p>male pipe x female pipe</p>		
<p><b>Swivel-Straight-Short</b> (pipe thread) Chrome plated brass - Anodized Alum, short lgth. 150wpsi Handles water/fuels/fertilizers etc.</p>			
<p>PS34MF</p>	<p>Male pipe x female pipe short swivel 3/4"</p>		
<p>PS100MF</p>	<p>Male pipe x female pipe short swivel 1"</p>		
<p>ZS10MF</p>	<p>Male pipe x female pipe short swivel 1 1/2"</p>		

<b>Swivel-90-Short</b> (pipe thread) Chrome plated brass/Anodized Alum, SS, short length. 150WPSI Handles			
PS34FF-90	female pipe x female pipe short swivel 90 3/4"		
PS100FF-90	female pipe x female pipe short swivel 90 1"		
ZS10FF-90	female pipe x female pipe short swivel 90 1 1/2"		
<b>Swivel-Straight (grooved)</b> Anodized Alum/SS 150WPSI Handles water/fuels/fertilizers etc.			
30GGSV-AL	3"grooved x grooved. Use! Actuated side spray		
40GGSV-AL	4"grooved x grooved. Use! Actuated side spray		
<b>Hydrant Fill Hose</b>			
MD250-2.5-FABNST-X-C-20			
MD250-2.5-FABNST-X-C-25			
MD250-2.5-FABNST-X-C-50			
<b>FIRE HOSES</b>			
<b>Medium Duty, Single Jacket</b>	single jacket fire hose, 250 wpsi, 500 tpsi		
MD250-11/2X50-NST			
MD250-11/2X100-NST			
MD250-21/2X50-NST			
MD250-21/2X100-NST			
	ALSO AVAILABLE IN NPSH (NPT)		
<b>Heavy Duty, Double Jacket</b>	double jacket fire hose, 400wpsi, 800tpsi		
DJ600-11/2X50-NST			
DJ600-11/2X100-NST			
DJ600-21/2X50-NST			
DJ600-21/2X100-NST			
	ALSO AVAILABLE IN NPSH (NPT)		

# SEE OUR OTHER CATALOGS!

Industrial Hose	Clamps	Flanges-Weld fittings-Flange Adapt		Grooved couplings & fittings	
					
Chain -Sure-flex cplgs	Wheeline -Hydrau	Gauges	Valves	Butterfly Valves	Diaphram V
					
Pipe Fittings	Pipe Niipple:s/Half	SS Pipe Fit	Brass Pipe Fittings	Brass Ind fittings	Brass Flare
					
Brass Puoo to oonneat	Yater Trude Part	Hydran:lic H	Hyd_Adapt	Hydraulic Crimp	Hydraulic Q
		